

# Alfa Laval ThinkTop V50 and V70

## Sensing and control

### Introduction

ThinkTop V50 and V70 takes valve control to a new level and all these new features are available on any Alfa Laval diaphragm, butterfly, single-seat and mixproof valves. While helping to increase production performance and secure traceability, ThinkTop V50 and V70 provide real-time information on the valve's operating status 24/7.

Both ThinkTop V50 and V70 are interchangeable with prior ThinkTop versions, and the appropriate variant is selected based on the number of solenoid valves. With only one sensor target and included adapter, ThinkTop V50 and V70 are easily retrofittable to existing Alfa Laval valves.

ThinkTop V50 and V70 come fitted with features such as Auto Setup, Live Setup and Flex Setup that streamline the setup process, making it quick and easy. Auto Setup and Live Setup recognise the valve based on its DNA profile and can complete the valve setup without any manual interaction.

The burst seat clean function is available on ThinkTop V70 and pulse seat clean function available on both ThinkTop V50 and V70. These valve position-based functions controls the optimum seat clean sequence of the valve, making it possible to save CIP time and achieve up to 95% CIP liquid savings for each seat clean.

### Application

ThinkTop V50 and V70 are designed for use in the dairy, food, beverage, and biopharma industries.

### Benefits

- Auto setup
- Automatic valve recognition
- Automatic selection of tolerance band
- Fast, Live and Flex Setup
- 360-degree LED indication
- Burst seat clean
- Pulse seat clean
- Exchangeable (threaded) air-fittings
- Interchangeable with ThinkTop classics

### Certificates

A selection of the essential certificates available on ThinkTop



### Working principles

The control unit offers a single sensor solution for diaphragm, butterfly, single-seat and mixproof valves and it can be fitted with up to three solenoid valves. ThinkTop converts the electrical PLC output signals into mechanical energy to energise, or de-energise, the air-operated valve, using the physical sensor target mounted on the valve stem.

Installation with Auto Setup or Live Setup is intuitive and fast. To initiate Auto Setup, simply press the "SELECT" button and then the "ENTER" button to begin the setup sequence. The ThinkTop automatically recognizes the type of valve and completes the programming sequence fast and efficiently. Alternatively, the ThinkTop can be set up, without dismantling the control head, using the built-in Live Setup feature for remote-configuration.

## Dimensions

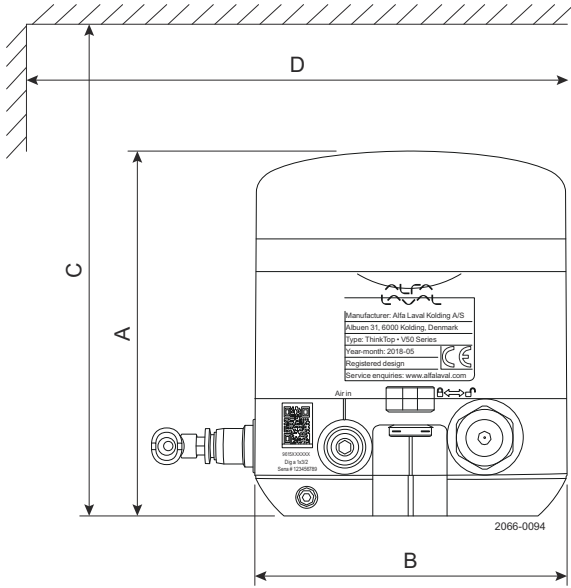


Figure 1. ThinkTop V 50

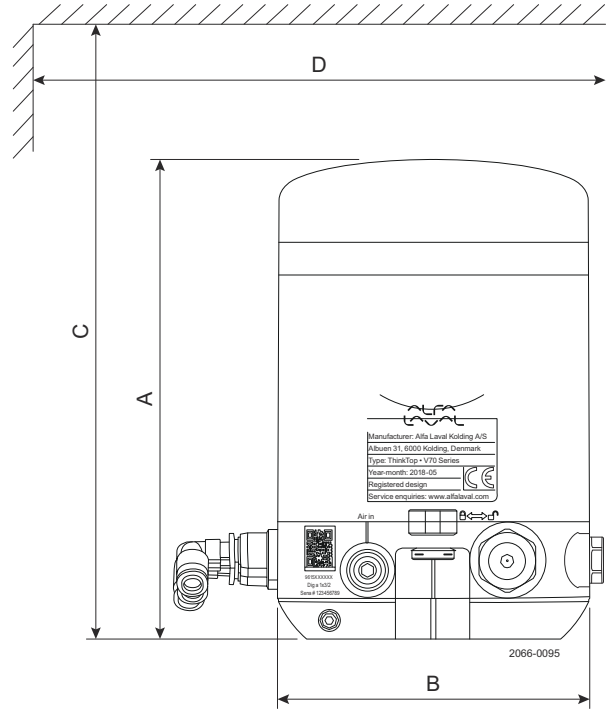


Figure 2. ThinkTop V 70

ThinkTop V 50		ThinkTop V 70	
	mm	Inch	
A	123	4.84	A
B	105	4.13	B
C	200	7.87	C
D	150	5.91	D
			mm
			Inch
			A
			B
			C
			D

## TECHNICAL DATA

### Material

Plastic parts	Nylon PA 12
Steel parts	1.4301 / 304
Gaskets	Nitril / NBR
Air fittings	Nickel plated / Nylon PA6
M12 chassis connector	Stainless steel / Gold plated pins

### Environment

Working temperature	-10 °C to +60 °C
Protection class (IP)	IP69K
Protection class (NEMA)	4, 4X and 6
Hazardous area	ATEX and IECEx in preparation

### Control board

Communication	See interfaces section
Sensor accuracy	± 0.1 mm
V50 – Valve stem length	Below < 65 mm
V70 – Valve stem length	Above > 65 mm
Mean Time To Failure (MTTF)	224 years
Approvals	UL/CSA Certificate: E174191

### Solenoid valve

Supply voltage	24 VDC ± 10%
Nominal power	0.3 W
Air supply	300-800 kPa (3-8 bar)
Type of solenoids	3/2-ways or 5/2-way
Number of solenoids	0-3
Manual hold override	Yes
Air quality	Class 3,3,3 acc. DIN ISO 8573-1
Air pressure	6-8 bar

## Solenoid valve

B10 data	5 million cycles
Recommendation	Operate once a month to prevent dry-out



### Note!

Throughout this leaflet, SV is used as an abbreviation for a solenoid valve

## Air fitting

Threaded air fitting G1/8	ø6 mm (Rim blue) or 1/4" (Rim Grey)
Elbow push-in fittings	ø6 mm (Rim blue) or 1/4" (Rim Grey)

## Cable connection

Main cable gland entry Digital	M16 (ø4 - ø10 mm <sup>2</sup> ) (0.16" - 0.39")
Main cable gland entry AS-I	M16 (ø2 - ø7 mm <sup>2</sup> ) (0.08" - 0.28")
Seat lift sensor cable gland entry	M12 (ø3.5 - ø7 mm <sup>2</sup> ) (0.14" - 0.28")
Max wire diameter	0.75 mm <sup>2</sup> (AWG20)

## M12 chassis connector

AS-Interface V50/V70	2 wire, 4-pin series
IO-Link interface V50/V70	3 wire, 4-pin series
Digital interface V50	6 wire, 8-pin series
Digital interface V70	10 wire, 12-pin series

## Vibration

Vibration	18 Hz-1kHz @ 7.54g RMS
Shock	100g

## Humidity

Constant humidity	+40 °C, 21 days, 93% R.H.
Cyclic humidity	-25 °C/+55 °C, 12 cycles
Working	93% R.H.

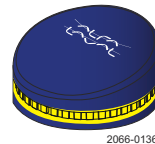
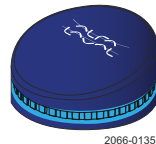
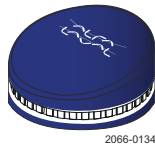
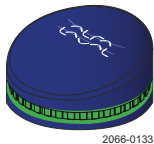
## Accessories by functionality

Upper seat lift surveillance	Kit
Valve "opening" speed reduction	0-100%. Outlet air fitting on ThinkTop
Valve "closing" speed reduction	0-100%. Inlet air fitting on actuator
Valve closing speed increase	Quick air exhaust, ø6 mm





## OPERATIONAL DATA

### ThinkTop LED indication

ThinkTop features a 360-degree light guide. When the sensor target is within the respective setup position band, the corresponding colour lights up.



## Valve position

	 All De-energised	 Main valve open Energised	 Upper seat lift Energised	 Lower seat push Energised	Between	
ThinkTop Mode	Factory setting	Green flashing	White flashing	Blue flashing	Yellow flashing	Off
	Operation	Green	White	Blue	Yellow	Off
	Not OK	Green/red flashing	White/red flashing	Blue/red flashing	Yellow/red flashing	Red flashing

## Auto and Live setup

Auto Setup is a rule-based function. If one of these rules are not present, Flex Setup must be used.

By default, ThinkTop V50 and V70 uses the de-Energised/Energised paradigm for valve positions feedback.

Parameter	Auto Setup/Live Setup	Flex Setup (retrofit mode)
Status feedback (OK or error)	Valve state (Fail safe signal)	Status error
Seat cleaning function	Enabled	Disabled
Valve operation monitor	Enabled	Disabled
Ext. sensor operation monitor	Enabled	Disabled
Interlock	Enabled	Disabled
Output (AS-i master input)	Special	Special
External sensor masking	Enabled	Disabled



**Note!**

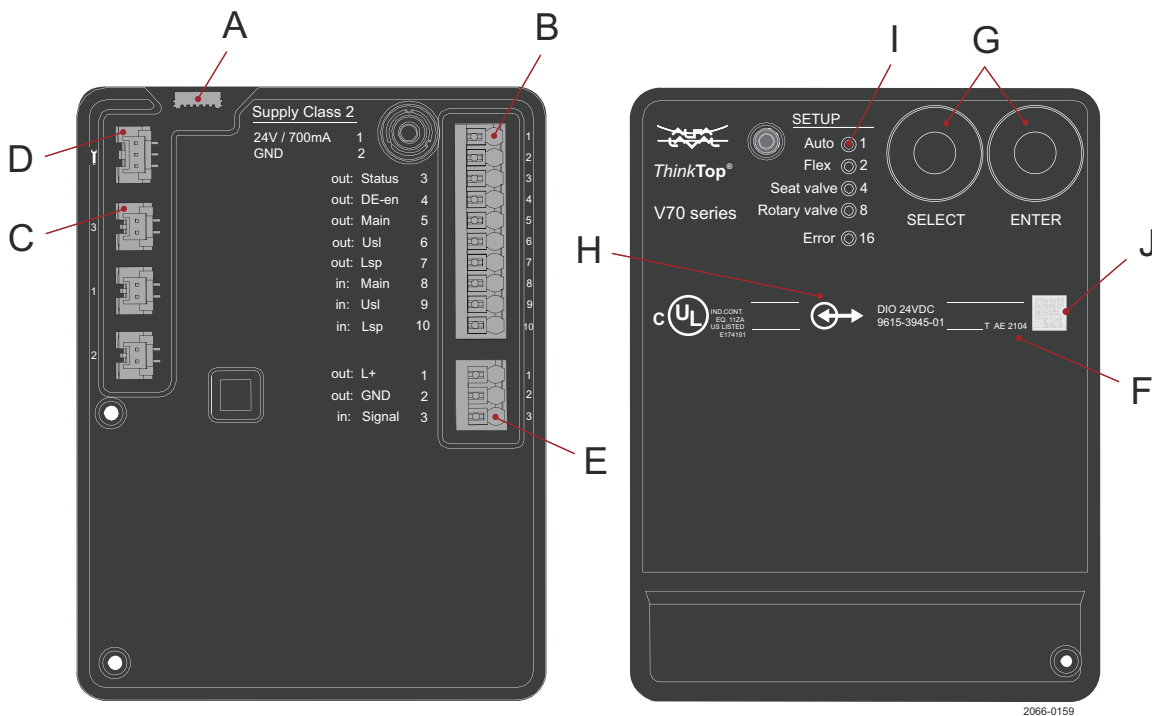
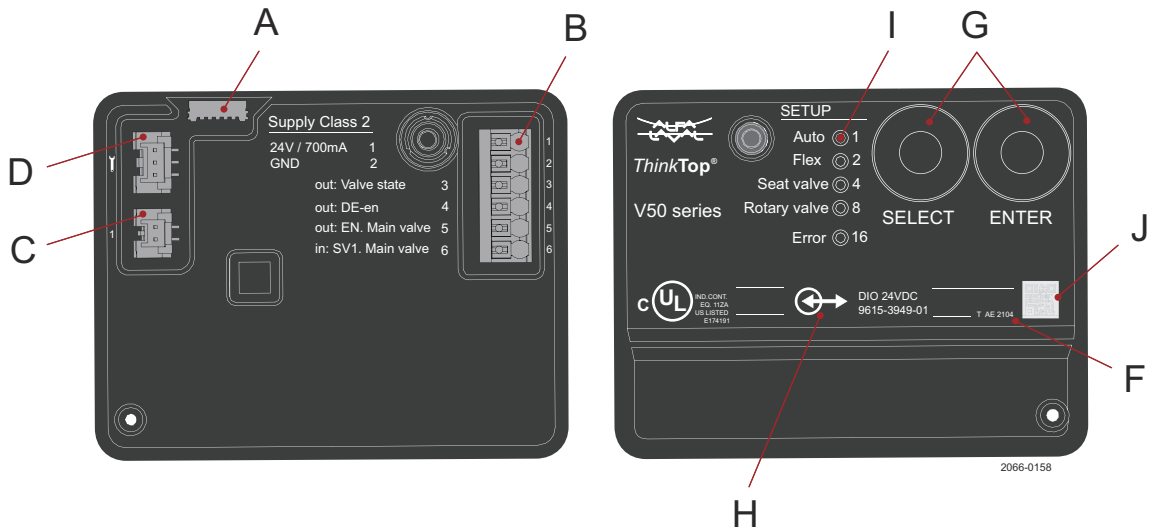
The "Fail safe signal" is always high for idle operation of ThinkTop and the valve

**Valve compatibility chart**

Use Anytime configurator for correct selection of ThinkTop V50 and V70 on different valve size and types

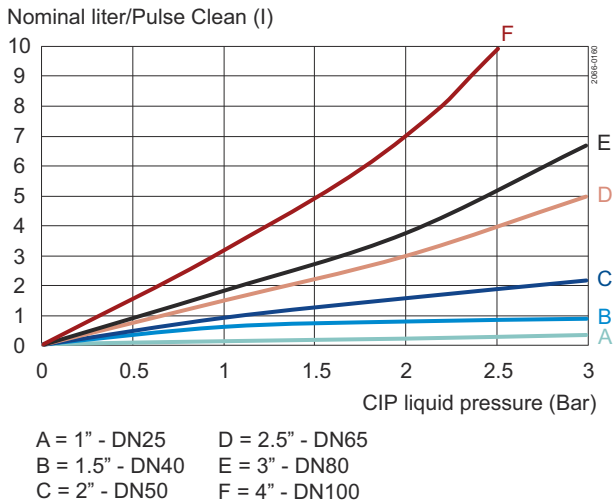
	Common applications (Auto / Live Setup)	Special applications (Flex Setup)	Incompatible valves
ThinkTop V50	<ul style="list-style-type: none"> <li>Single Seat valves</li> <li>Small Single Seat valve</li> <li>Butterfly valves</li> <li>Diaphragm valves</li> <li>Ball valves</li> <li>Shutter valves</li> <li>Double seat valves</li> <li>Double seal valve</li> </ul>	<ul style="list-style-type: none"> <li>• ThinkTop classic retrofit mode or alternative setup with no restrictions</li> <li>• Feedback structure such as the open/closed valve feedback</li> <li>• All SSV (1/2" - 4") NO, shut off, maintainable, need to be setup as a rotary valve</li> <li>• Application with no solenoid valve, feedback indication only</li> <li>• One control unit to control multiple valves-actuators</li> <li>• SMP-BC where using 2 solenoid valves to operate main valve and pilot leak-detect valves independently</li> </ul>	<ul style="list-style-type: none"> <li>• Valves without actuator stem and mushrooms</li> <li>• Koltek Type 633 three position actuator, valve size 1" – 3"</li> <li>• Regulating valves</li> <li>• Safety valves</li> <li>• Sample valves</li> <li>• SMP-EC</li> <li>• 700 series</li> <li>• Other valve brands</li> </ul>
ThinkTop V70	<ul style="list-style-type: none"> <li>In addition to the ThinkTop V50 valves</li> <li>Double seat valves</li> <li>Double seal valve</li> <li>Long stroke single seat valves</li> <li>Diaphragm valves</li> <li>Air/Air valves</li> </ul>		

## Overview of control board V50 and V70



- A: LED indication lamp
- B: Spring loaded terminals
- C: Solenoid valve connectors
- D: Diagnostic port (Alfa Laval)
- E: Upper seat lift sensor terminal
- F: Control board - Firmware version
- G: Push buttons "Select" and "Enter"
- H: Symbol for electrical interface
- I: LEDs for unit status display
- J: Non-public QR code

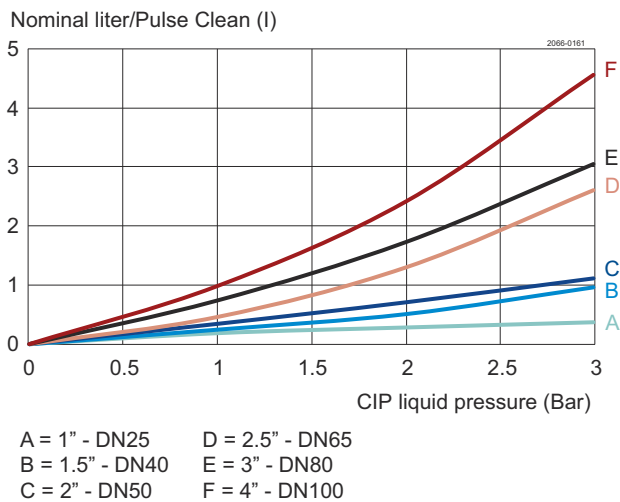




**Figure 1. LKAT-T ø85 and Butterfly valves**

**1" DN25 to 4" DN100**

**Air pressure 6 bar**



**Figure 2. Unique SSV valves**

**1" DN25 to 4" DN100**

**Air pressure 6 bar**

### ThinkTop burst seat clean

For efficient cleaning of the gaskets in a Mixproof valve during pressurized CIP flow. The burst clean mode is disabled as default and can be enabled either locally on the ThinkTop or remotely from the control system. The feature is available in ThinkTops configured with two or three solenoid valves.

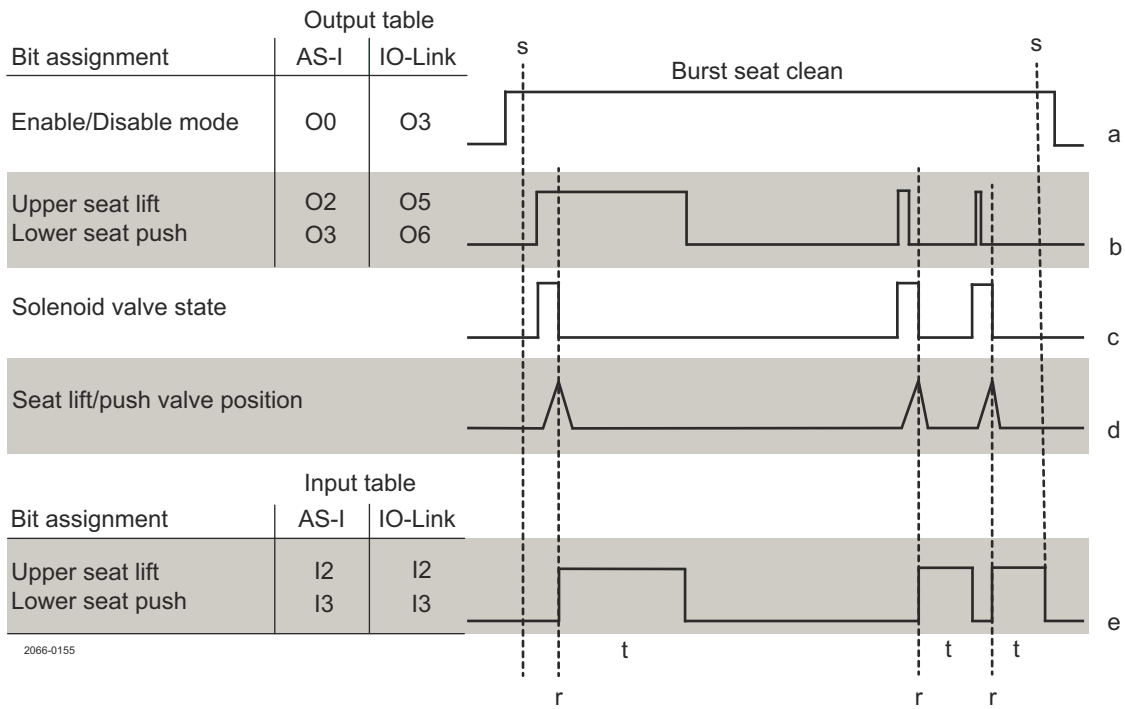
For manual push-button setup, burst seat clean feature can be enabled or disabled on the ThinkTop V70 control board by doing the following. Press "SELECT" (4 times) until LED # 4 flashes, then press 'ENTER' to activate or deactivate the function.

For remotely PLC control of the burst clean mode please refer to the bit table of AS-Interface and IO-Link or the function diagram. With PLC control, the burst clean mode can easily alternate between high CIP flow pressure or CIP gravity cleaning.

When the PLC burst clean mode bit goes **"high"**, the burst seat clean function is enabled, leaving the setting locked and cannot be switched locally or from the HMI system. When the PLC burst clean mode bit goes "low" the function is disabled. While the PLC input is low the mode can be toggled locally on the ThinkTop.

If ThinkTop V70 is set up using Auto Setup without the upper seat lift sensor, the function uses the stored setup stroke time for "Lower seat push" plus 1 second extra for when the solenoid valve is deactivated.

How to control the burst cleaning function, please set up and follow the function diagram. The PLC input duration (b) to ThinkTop must be at least 500 ms.



- a: Push button or electrical signal from PLC
- b: Electrical signal from PLC
- c: Electrical activation inside ThinkTop
- d: Physical valve movement
- e: Visual LED and electrical signal to PLC
- r: Valve position reached
- s: Signal high during Burst seat cleaning
- t: Min. 2 sec.

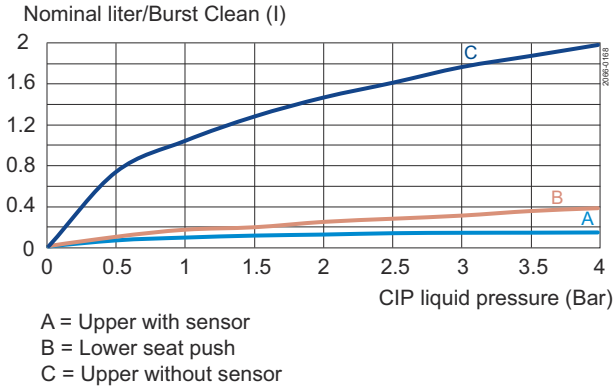
When the valve-position is reached, the burst seat clean function is released, and the valve returns to the starting position. After which then ready again after 2 seconds to perform another burst cleaning. A minimum two-second (t) electrical signal and visual feedback (e) is provided as a handshake for successful completion of a burst seat clean.



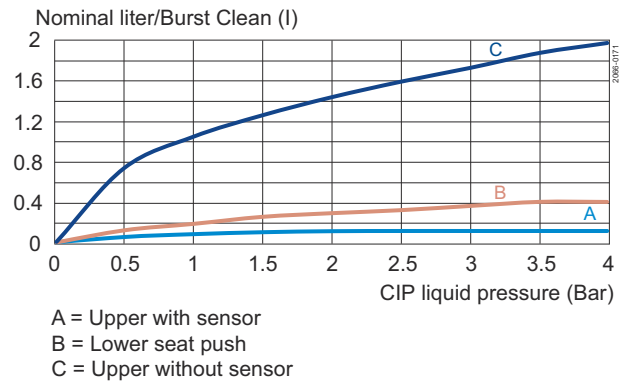
**Burst water consumption graph**

ThinkTop V70 CIP water consumption during Burst seat clean on different Mixproof valves, provided with 6 bar air pressure:

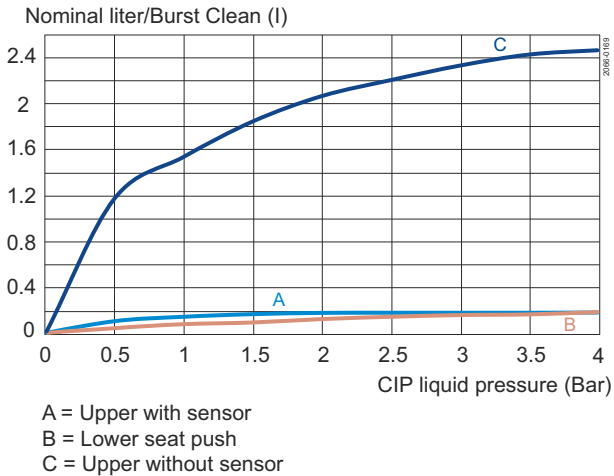
Pipe velocities across valves >1.5 m/s



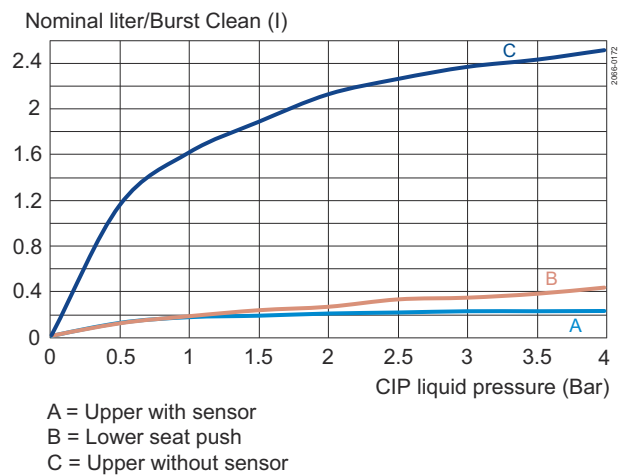
**Figure 3. Unique Mixproof valve / Unique Mixproof CP-3 valve**  
**1.5" DN40 and 2" DN50**



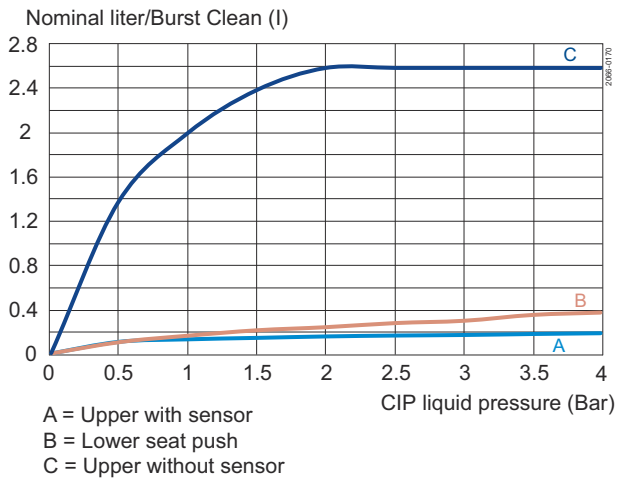
**Figure 4. Unique Mixproof valve / Unique Mixproof CP-3 valve with lower flush**  
**1.5" DN40 and 2" DN50**



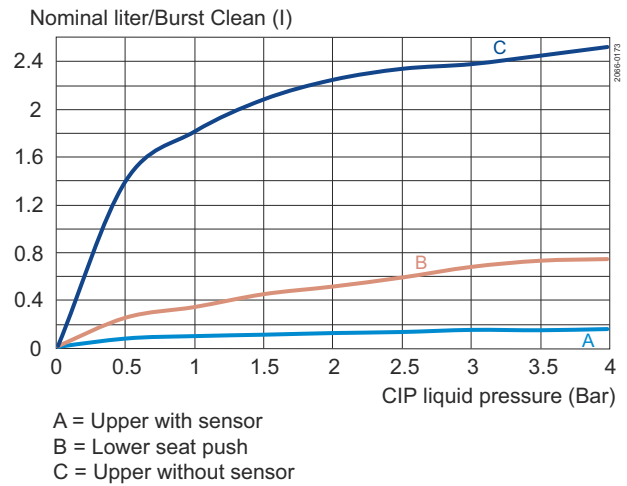
**Figure 5. Unique Mixproof valve / Unique Mixproof CP-3 valve**  
**2.5" DN65 and 3" DN80**



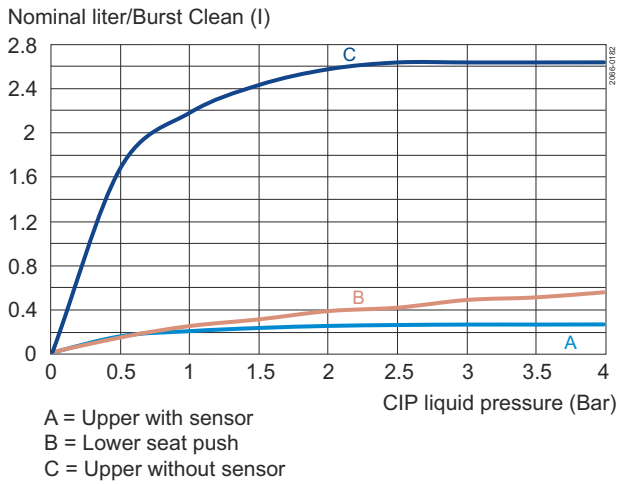
**Figure 6. Unique Mixproof valve / Unique Mixproof CP-3 valve with lower flush**  
**2.5" DN65 and 3" DN80**



**Figure 7. Unique Mixproof valve / Unique Mixproof CP-3 valve**  
4" DN100



**Figure 8. Unique Mixproof valve / Unique Mixproof CP-3 valve with lower flush**  
4" DN100



**Figure 9. Unique Mixproof valve / Unique Mixproof CP-3 valve**  
5" DN125 and 6" DN150

### Compatible valve actuators

List of compatible valve actuators where pulse seat clean and burst seat clean can be applied:

ThinkTop V50 and V70	Valve actuators	Applicable
Pulse seat clean	i-Series	Yes
	Single Seat Valves	Yes
	Butterfly Valves - LKLA-T ø85	Yes
	Butterfly Valves - LKLA-T ø133	No
	Diaphragm valves	No
	Ball valves	No
	Shutter valves	No
	Small Single Seat Valves	No
	Safety and Sample valves	No
	ThinkTop 70	Valve actuators
Burst seat clean	Air/Air valves	Yes
	700 series	No
	2 Step valves	No
	Long stroke valves	Yes
	Double seat valves	Yes
	Double seal valves	No

## Valve state – Fail safe signal

The following table gives an overview of behaviour per Error condition where the valve state signal goes low. Further description of the various Error conditions can be found in the ThinkTop Instruction Manual, section 5,2

Valve state is a decentralized functionality, available for all ThinkTop variants and a feature that can be used for monitoring process issues or to ease and simplify the PLC programming of a valve surveillance.

Error Code #	Error description	ThinkTop Digital Valve state	ThinkTop AS-Interface Valve state not available	ThinkTop IO-Link Valve state
		Main valve FAIL SAFE SIGNAL DE-ENERGIZED SIGNAL behaviour	Main valve not available DE-ENERGIZED SIGNAL behaviour	Main valve FAIL SAFE SIGNAL DE-ENERGIZED SIGNAL behaviour
15	Key lock active	na	na	na
16	Sensor target missing	Drops low	Drops low	Drops low
17	Setup prerequisite issue Missing peripherals	Not connected	Not connected	Not connected
18	Pneumatic part issue	Not connected	Not connected	Not connected
19	Seat lift sensor issue	Drops low	Drops low	Drops low
20	Position not reached	Drops low	Drops low	Drops low
21	Unexpected valve movement	Drops low	Drops low	Drops low
22	Seat-lift sensor missing	Drops low	Drops low	Drops low
23	Solenoid valve 1 missing	Drops low	Not connected	Drops low
24	Solenoid valve 2 missing	Drops low	Not connected	Drops low
25	Solenoid valve 3 missing	Drops low	Not connected	Drops low
26	Interlock warning	Drops low	Not connected	Drops low
27	Output short circuit (Digital)	Drops low	Not connected	Not connected
28	Setup aborted	Not connected	Not connected	Not connected
29	Blocked button	Drops low	Not connected	Drops low
30	Voltage Low (Digital)	Drops low	Not connected	Not connected
30	Communication failure (IO-Link)	Not connected	Not connected	Drops low
31	Safety stop	Drops low	Drops low	Drops low
32 <sup>1</sup>	Pressure shock event	Not connected	Not connected	Not connected

<sup>1</sup> This event is not treated as an error

## Default bitmapping

The default settings apply to both Digital, AS-Interface and IO-Link

### ThinkTop V50 truth signal table: default factory setting

	DE-EN (I0) close	MAIN (I1) open	Valve state (Fail safe signal)
DE-EN (No active SV)	1	0	1
MAIN SV1 active (O1)	0	1	1

### ThinkTop V70 truth signal table: default factory setting

	DE-EN (I0) all closed	MAIN (I1) open	USL (I2) open	LSP (I3) open	Valve state (Fail safe signal)
DE-EN (No active SV)					
Both seats closed	1	0	0	0	1
Lower seat in closed position					
Upper seat in closed position					
MAIN SV1 active (O1)					
Lower seat in open valve position	0	1	0	0	1
Upper seat not closed					
USL SV2 active (O2)					
Upper seat not close	0	0	1	0	1
Lower seat in closed position					
LSP SV3 active (O3)					
Lower seat in seat push position	0	0	0	1	1
Upper seat in closed position					

## USA compliance option

Available to all ThinkTop V70 variants. The USA compliance option refers to a bit mapping interface used in the USA on Mixproof valves, fitted with 3 solenoid valves. This USA bitmapping can be enabled after or before auto setup.

US regulations require independent closed position feedback signals for upper seat lift and lower seat push in a Mixproof valve application

The USA bitmapping are enabled or disabled on the ThinkTop V70 control board. Press "SELECT" (5 times) until LED no 8 flashes, and then press "ENTER" to enable or disable. This option is also available as an adjustable IO-Link parameter.

The USA compliance option is from factory disabled by default. However, if it is enabled and there is a manual reset to factory default, the USA compliance option remains enabled.



## USA bitmapping

The information in the table is based on the following setup:

- ThinkTop V70 with 3 solenoid valves
- IFT series seat lift sensor of type NO or NC
- Mixproof valve with both seats installed (balanced or unbalanced upper plug)
- Any combination of above valve type and sensor type

	DE-EN (I0) Both closed	MAIN (I1) open	USL (I2) closed	LSP (I3) closed	Valve state (Fail safe signal)
DE-EN (No active SV) Both seats closed Lower seat in closed position Upper seat in closed position	1	0	1	1	1
MAIN SV1 active (O1) Lower seat in open valve position Upper seat not closed	0	1	0	0	1
USL SV2 active (O2) Upper seat not closed Lower seat in closed position	0	0	0	1	1
LSP SV3 active (O3) Lower seat in seat push position Upper seat in closed position	0	0	1	0	1

## Digital interface

### ThinkTop Digital 24V DC

Device name	ThinkTop V50 24V Digital - PNP ThinkTop V70 24V Digital - PNP
Voltage supply	<ul style="list-style-type: none"><li>• 24 VDC <math>\pm</math> 10%; according to EN 61131-2</li></ul>
Protection	<ul style="list-style-type: none"><li>• Reverse polarity (24 VDC <math>\pm</math> 10%); EN 61131-2</li><li>• Voltage interruption and brown-out; EN61131</li><li>• Short circuit; EN 61131</li></ul>
Current consumption	<ul style="list-style-type: none"><li>• Nominal 30mA (Idle)</li></ul>
Outputs to PLC	<ul style="list-style-type: none"><li>• Max 100mA (solenoid valve and seat lift sensor active)</li></ul>
PLC input card	<ul style="list-style-type: none"><li>• Max rated 24V/100A</li></ul>
UL supply	<ul style="list-style-type: none"><li>• Class 2 according to cULus</li></ul>
Voltage-drop	<ul style="list-style-type: none"><li>• Typical 3V at 50 mA</li></ul>
Terminal type	<ul style="list-style-type: none"><li>• Spring force push-in technology</li><li>• Supports nominal wire cross-section between 1.0 mm<sup>2</sup> [17AWG] and 0.30 mm<sup>2</sup> [22AWG]</li><li>• Supports wire and ferrules for wire cross-section of 0.75 mm<sup>2</sup> [ 18AWG] with pin length 12 mm</li></ul>



## Electrical connections

### ThinkTop V50

Terminals	Control board	Colour code wires
1	24V	BN (brown)
2	GND	BU (blue)
3	out: Status	WH (white)
4	out: DE-EN	BK (black)
5	out: EN. Main valve	GY (grey)
6	in: SV1 . Main valve	PK (pink)

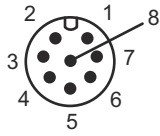
### ThinkTop V70

Terminals	Control board	Colour code wires
1	24V	BN (brown)
2	GND	BU (blue)
3	out: Status	WH (white)
4	out: DE-EN	BK (black)
5	out: EN. Main valve	GY (grey)
6	out: USL. Upper seat lift	PK (pink)
7	out: LSP. Lower seat push	VT (violet)
8	in SV1. Main valve	YE (yellow)
9	in SV2. Upper seat lift	GN (green)
10	in SV3. Lower seat push	RD (red)
	<b>Seat lift sensor</b>	
E1	L+	BN (brown)
E2	GND	BU (blue)
E3	Signal	BK (black)

## ThinkTop V50

M12 option (8-pin A-coded plug)

Pin numbers and terminal numbers are aligned

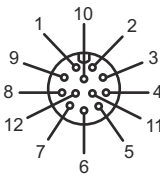
M12 Chassis plug connector	Control board Terminal numbers	M12 pin numbers wire colors
	<b>Solenoid valve</b>	<b>0 or 1x3/2-way</b>
	1: 24V	Pin 1: BN (brown)
	2: GND <sup>1</sup>	Pin 3: BU (blue)
	3: out: Valve state (Valve state) <sup>1</sup>	Pin 2: WH (white)
	4: out: DE-EN	Pin 4: BK (black)
	5: out: EN. Main valve	Pin 5: GY (grey)
	6: in SV1. Main valve	Pin 6: PK (pink)
	7: nc	-
8: nc	-	

<sup>1</sup> Please be mindful of the difference between the number sequence of the control board terminal and the M12 plug pins

## ThinkTop V70

M12 option (12-pin A-coded plug)

Pin numbers and terminal numbers are aligned

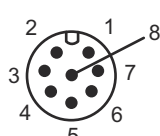
M12 Chassis plug connector	Control board Terminal numbers	M12 pin numbers wire colors
	<b>Solenoid valves</b>	<b>0, 1, 2 and 3x3/2-way or 1x5/2-way</b>
	1: 24V	Pin 1: BN (brown)
	2: GND <sup>1</sup>	Pin 3: BU (blue)
	3: out: Status (Valve state) <sup>1</sup>	Pin 2: WH (white)
	4: out: DE-EN	Pin 4: BK (black)
	5: out: EN. Main valve	Pin 5: GY (grey)
	6: out: USL Upper seat lift	Pin 6: PK (pink)
	7: out: LSP Lower seat push	Pin 7: VT (violet)
	8: in SV1. Main valve	Pin 8: YE (yellow)
	9: in SV2. Upper seat lift	Pin 9: GN (green)
	10: in SV3. Lower seat push	Pin 10: RD (red)
	11: nc	-
12: nc	-	

<sup>1</sup> Please be mindful of the difference between the number sequence of the control board terminal and the M12 plug pins

## ThinkTop V70

M12 accessory (8-pin A-coded plug)

Suggestions for alignment of M12 pin numbers and terminal numbers

M12 Chassis plug connector	Control board Terminal numbers	M12 pin numbers wire colors		
		0, 1x3/2 or 5/2-way	2x3/2-way	3x3/2-way
	<b>Solenoid valve</b>	<b>0, 1x3/2 or 5/2-way</b>	<b>2x3/2-way</b>	<b>3x3/2-way</b>
	1: 24V	Pin 1: BN (brown)	Pin 1: BN (brown)	Pin 1: BN (brown)
	2: GND <sup>1</sup>	Pin 3: BU (blue)	Pin 3: BU (blue)	Pin 3: BU (blue)
	3: out: Status (Valve state) <sup>*1</sup>	Pin 2: WH (white)	Pin 2: WH (white)	Pin 2: WH (white)
	4: out: DE-EN	Pin 4: BK (black)	Pin 4: BK (black)	Pin 4: BK (black)
	5: out: EN. Main valve	Pin 5: GY (grey)	Pin 5: GY (grey)	Pin 5: GY (grey)
	6: out: USL Upper seat lift	Pin 6: PK (pink)	Pin 6: PK (pink)	-
	7: out: LSP Lower seat push	Pin 7: VT (violet)	-	-
	8: in SV1. Main valve	Pin 8: YE (yellow)	Pin 8: YE (yellow)	Pin 8: YE (yellow)
	9: in SV2. Upper seat lift <sup>1</sup>	-	Pin 7: VT (violet)	Pin 6: PK (pink)
10: in SV3. Lower seat push <sup>1</sup>	-	-	Pin 7: VT (violet)	

<sup>1</sup> Please be mindful of the difference between the number sequence of the control board terminal and the M12 plug pins

## ThinkTop AS-Interface

Device name	ThinkTop V50 ASI2 & ThinkTop V50 ASI3 ThinkTop V70 ASI2 & ThinkTop V70 ASI3
Supply voltage	<ul style="list-style-type: none"><li>AS-Interface 29.5 – 31.6 VDC</li></ul>
Protection	<ul style="list-style-type: none"><li>Reverse polarity (24 VDC <math>\pm</math> 10%); EN 61131-2</li><li>Voltage interruption and brown-out; EN 61131</li><li>Short circuit; EN 61131</li></ul>
Current consumption	<ul style="list-style-type: none"><li>Nominal: 30 mA (idle)</li><li>Max 100 mA (solenoid valve and seat lift sensor active)</li></ul>
Terminal type	<ul style="list-style-type: none"><li>Spring force push-in technology</li><li>Supports nominal wire cross-section between 1.0 mm<sup>2</sup> [17AWG] and 0.30 mm<sup>2</sup> [22AWG]</li><li>Supports wire and ferrules for wire cross-section of 0.75 mm<sup>2</sup> [18AWG] with pin length 12 mm</li></ul>
AS-I specification v2.11	<ul style="list-style-type: none"><li>Supports standard addressing and are compatible with M0-M4 AS-I master profiles, allows up to 31 nodes on an AS-I network</li><li><b>Slave profile = 7FFF</b></li></ul>
AS-I specification v3.0	<ul style="list-style-type: none"><li>Supports extended A/B addressing and is compatible with M4 AS-I master profile, allows up to 62 nodes on an AS-I network</li><li><b>Slave profile = 7A77</b></li></ul>
AS-I addressing	<ul style="list-style-type: none"><li>Default slave address (Node) is = <b>0</b></li><li>Address (Node) changes with a standard handheld AS-I addressing device or via AS-I Master Gateway</li></ul>





## AS-Interface bit table

For the AS-Interface versions, the following bit assignment will be used

PLC system / Gateway Output table	ThinkTop V50	PLC system / Gateway Output table	ThinkTop V70
Pulse clean trigger (1 solenoid valve)	O0	Pulse clean trigger (1 solenoid valve)	O0
SV1. Main valve	O1	Burst clean mode (2 or 3 solenoid valves)	O1
SV2. Upper seat lift	nc		O2
SV3. Lower seat push	nc		O3

PLC system / Gateway Input table	ThinkTop V50	PLC system / Gateway Input table	ThinkTop V70
DE-EN	I0		I0
EN. Main valve	I1		I1
Upper seat lift	nc		I2
Lower seat push	nc		I3

## Electrical connections

### ThinkTop V50

Terminal	Control board	Colour code wires
1	AS-i +	BN (brown)
2	AS-i -	BU (blue)

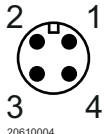
### ThinkTop V70

Terminal	Control board	Colour code wires
1	AS-i +	BN (brown)
2	AS-i -	BU (blue)
<b>Seat lift sensor</b>		
E1	L+	BN (brown)
E2	GND	BU (blue)
E3	Signal	BK (black)

### ThinkTop V50 and ThinkTop V70

M12 option (4-pin A-coded plug)

Pin numbers and terminal numbers are aligned

M12 Chassis plug connector	Control board Terminal numbers Functions	M12 pin assignments wire colours
	1: AS-i +	Pin 1: BN (brown)
	2: nc	-
	3: AS-i -	Pin 3: BU (blue)
	4: nc	-

## IO-Link interface

### ThinkTop IO-Link

In addition to process indication and control, the IO-Link variant enables diagnostic information and features additional functionality that is unique to ThinkTop.

If new functionality is implemented in ThinkTopV50 and V70, then a new IODD and interface description is generated. Both the new and old IODD will be included in the revision of the "ThinkTop IO-Link zip-file".

It's recommended to just add them all to the preferred IO-Link configuration tool. The configuration tool will automatically match the correct IO-Link with the connected ThinkTop.

Device name	ThinkTop V50 IOL ThinkTop V70 IOL
IO-Link supply voltage	<ul style="list-style-type: none"> <li>24 VDC ± 10%; according to EN 61131-2</li> </ul>
Protection	<ul style="list-style-type: none"> <li>Reverse polarity (24 VDC ± 10%); EN 61131-2</li> <li>Voltage interruption and brown-out; EN61131</li> <li>Short circuit; EN 61131</li> </ul>
Current consumption	<ul style="list-style-type: none"> <li>Nominal: 30 mA (idle)</li> <li>Max 100 mA (solenoid valve and seat lift sensor active)</li> </ul>
Terminal type	<ul style="list-style-type: none"> <li>Spring force push-in technology</li> <li>Supports nominal wire cross-section between 1.0 mm<sup>2</sup> [17AWG] and 0.30 mm<sup>2</sup> [22AWG]</li> <li>Supports wire and ferrules for wire cross-section of 0.75 mm<sup>2</sup> [18AWG] with pin length 12 mm</li> </ul>
ThinkTop control board revisions	<ul style="list-style-type: none"> <li>The interface description "<b>Before</b> Dec. 2021" match ThinkTop control boards of revisions AA to AD</li> <li>The interface description marked "<b>After</b> Dec. 2021" match ThinkTop control boards of revision AE or later</li> </ul>
Download of IO-Link files	<ul style="list-style-type: none"> <li>Alfa Laval Anytime and ThinkTop configurator</li> <li>Go to <a href="http://www.alfalaval.com">www.alfalaval.com</a> ThinkTop and documentation</li> <li>Go to <a href="http://www.io-link.com">www.io-link.com</a> Click IO-Link finder and key ThinkTop</li> </ul>
IO-Link interface tool	<ul style="list-style-type: none"> <li>IFM E30390 IO-Link Interface / USB IO-Link master</li> <li>IFM LR Device – Line recorder</li> </ul>
<b>ThinkTop V50</b>	<ul style="list-style-type: none"> <li>"<b>Before</b> Dec. 2021" match Device ID 1</li> <li>"<b>After</b> Dec. 2021" match Device ID 9</li> </ul>
<b>ThinkTop V70</b>	<ul style="list-style-type: none"> <li>"<b>Before</b> Dec. 2021" match Device ID 2</li> <li>"<b>After</b> Dec. 2021" match Device ID 10</li> </ul>
Cable length to IO-Link master	<ul style="list-style-type: none"> <li>Max 20 meters</li> </ul>
Transmission rate	<ul style="list-style-type: none"> <li>COM 2 (38.4 kBaud)</li> </ul>
Minimum cycle time	<ul style="list-style-type: none"> <li>5 ms</li> </ul>
Data storage	<ul style="list-style-type: none"> <li>yes</li> </ul>
Profiles	<ul style="list-style-type: none"> <li>na</li> </ul>
SIO mode	<ul style="list-style-type: none"> <li>no</li> </ul>
Port class	<ul style="list-style-type: none"> <li>A</li> </ul>



### IO-Link data table

For the IO-Link version, the bit assignment and diagnostic data can be found in the manual "IO-Link Interface Description" for ThinkTop V50 and ThinkTop V70 respectively. Go to [www.alfalaval.com](http://www.alfalaval.com) ThinkTop V and documentation

On ThinkTop V50 and ThinkTop V70 control board, using the IO-Link interface tool from IFM, all parameter settings and visualisation data are available through the diagnostic connection port

From the "IO-Link Interface Description" the table below shows an overview of the data storage parameters. When replacing a ThinkTop V-series on a process plant, some data are re-stored, included in the new ThinkTop V-series, and other data must be reassigned again, excluded in the new ThinkTop V-series.

Please note that data storage is a feature that must be actively selected in the PLC's hardware configuration when setting up the IO-link master.

Included	Excluded
Customization <ul style="list-style-type: none"> <li>• Application Specific Tag</li> <li>• Error modifier timeout</li> <li>• Function Tag</li> <li>• Location Tag</li> <li>• Power save</li> <li>• Button lock</li> <li>• RGB colour</li> <li>• Seat valve pulse</li> <li>• Rotary valve pulse</li> <li>• USA bit mapping</li> </ul>	Control board ID <ul style="list-style-type: none"> <li>• Vendor Name</li> <li>• Vendor Text</li> <li>• Product Name</li> <li>• Product ID</li> <li>• Product Text</li> <li>• Serial Number</li> <li>• Hardware Version</li> <li>• Firmware Version</li> <li>• Prod Date</li> </ul>
	Setup data <ul style="list-style-type: none"> <li>• Setup positions</li> <li>• Setup state</li> </ul>
	Diagnostics <ul style="list-style-type: none"> <li>• SV-activations</li> <li>• SV-ON_time</li> <li>• PV-SetupStrokeEn</li> <li>• PV-SetupStrokeDeEn</li> <li>• PressureShockCnt</li> <li>• Temp</li> <li>• Log</li> </ul>

## Electrical connections

### ThinkTop V50

Terminal	Control board	Colour code wires
1	L +24V	BN (brown)
2	L -GND	BU (blue)
3	IO-Link signal	BK (black)

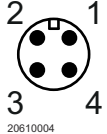
### ThinkTop V70

Terminal	Control board	Colour code wires
1	L +24V	BN (brown)
2	L -GND	BU (blue)
3	IO-Link signal	BK (black)
	<b>Seat lift sensor</b>	
E1	L+	BN (brown)
E2	GND	BU (blue)
E3	Signal	BK (black)

### ThinkTop V50 and V70

M12 option (4-pin A-coded plug)

Pin numbers and terminal numbers are aligned

M12 Chassis plug connector	Control board Terminal numbers	M12 pin assignments wire colours
 <small>20610004</small>	1: L +	Pin 1: BN (brown)
	2: nc	-
	3: L -	Pin 3: BU (blue)
	4: Out1	Pin 4: BK (black)

This document and its contents are subject to copyrights and other intellectual property rights owned by Alfa Laval Corporate AB. No part of this document may be copied, re-produced or transmitted in any form or by any means, or for any purpose, without Alfa Laval Corporate AB's prior express written permission. Information and services provided in this document are made as a benefit and service to the user, and no representations or warranties are made about the accuracy or suitability of this information and these services for any purpose. All rights are reserved.

200006074-3-EN-GB

© Alfa Laval Corporate AB



**ALFA ENGENHARIA**

Rua Dom Pedro Henrique de Orleans e Bragança, 809 - CEP 05117-002 - Vila Jaguara - São Paulo-SP  
[www.alfaengenharia.com.br](http://www.alfaengenharia.com.br) - [contato@alfaengenharia.com.br](mailto:contato@alfaengenharia.com.br)  
Tel:+55 11 3644-5476