

# Alfa Laval MultiJet 25

## Rotary jet heads

### Introduction

The Alfa Laval MultiJet 25 is a rotary jet head tank cleaning machine for use in industrial environments. Built to clean tanks with capacities from 15 and 150 m<sup>3</sup>, it combines pressure and flow to create high-impact cleaning jets rotate in a repeatable and reliable 360-degree cleaning pattern.

The MultiJet 25 minimizes the consumption of water and cleaning media. Easy to customize to meet customer requirements, it allows companies to spend less time cleaning and more time producing.

### Application

The Alfa Laval MultiJet 25 is designed for the removal of the toughest residues from industrial tanks across a broad range of industries, such as the home care, chemical, pulp and paper, ethanol, starch, and oil industries.

### Benefits

- 60% faster cleaning = more time for production
- Saves up to 70% of your cleaning cost
- Eliminates the need for confined space entry for manual tank cleaning
- High-impact cleaning in a 360° repeatable cleaning pattern
- Cleaning process can be validated using Alfa Laval Rotacheck

### Standard Design

The choice of nozzle diameters can optimize jet impact length and flow rate at the desired pressure. A 2.1 material certificate and an ATEX certification are available.

Alfa Laval offers a wide range of tank cleaning machines suitable for different duties and industries. An alternative that offers performance similar to the Alfa Laval MultiJet 25 is the Alfa Laval GJ PF, which is ideal applications that require a small tank inlet opening.

### Working principle

The high-impact jet stream from the Alfa Laval MultiJet rotary jet head covers the entire surface of the tank interior in a successively denser pattern. This achieves a powerful mechanical impact with a low volume of water and cleaning media.

The flow of the cleaning fluid makes the nozzles perform a geared rotation around the vertical and horizontal axes. In the



first cycle, the nozzles lay out a course pattern on the tank surface.

The subsequent cycles gradually make the pattern denser until at full cleaning pattern is reached. Once the full cleaning pattern is reached, the machine will start over again and continue to perform the next full cleaning pattern.

### Certificates

2.1 material certificate and ATEX.



## TECHNICAL DATA

Lubricant:	Self-lubricating with the cleaning fluid
Max. throw length:	9 - 14 m
Impact throw length:	4 - 8 m

### Pressure

Working pressure:	3 - 8 bar
Recommended pressure:	5 - 6.5 bar

## Cleaning Pattern

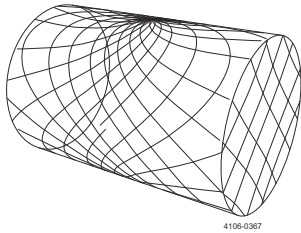

First cycle

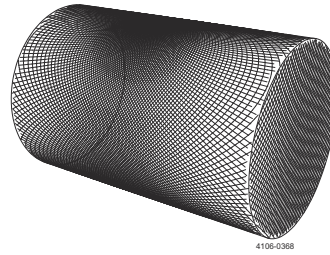

Full pattern

The above drawings show the cleaning pattern achieved on a cylindrical horizontal vessel. The difference between the first cycle and the full pattern represents the number of additional cycles available to increase the density of the cleaning.

## PHYSICAL DATA

### Materials

316L (UNS S31603), Duplex steel (UNS N31803), Duplex steel (UNS S 21800), EPDM<sup>1</sup>, PEEK<sup>1</sup>, PVDF<sup>1</sup>, PFA<sup>1</sup>

<sup>1</sup> FDA compliance 21CFR§177

Surface finish:	Exterior finish: Glass blasted
-----------------	--------------------------------

### Temperature

Max. working temperature:	95 °C
Max. ambient temperature:	140 °C

Weight:	5.1 kg
---------	--------

### Connections

Standard female thread:	1" Rp (BSP) or NPT
-------------------------	--------------------

## Caution

Avoid hydraulic shock, hard and abrasive particles in the cleaning liquid, as this can cause increased wear and/or damage of internal mechanisms. In general, a filter in the supply line is recommended. Do not use for gas evacuation or air dispersion. For steaming we refer to the manual.

## Qualification Documentation

### Documentation specification

ATEX	ATEX approved machine for use in explosive atmospheres Category 1 for installation in zone 0/20 in accordance with Directive 2014/34/EU II 1G Ex h IIC 85 °C ... 175 °C Ga II 1D Ex h IIC T85 °C ... T140 °C Da
------	--

### Flow rate

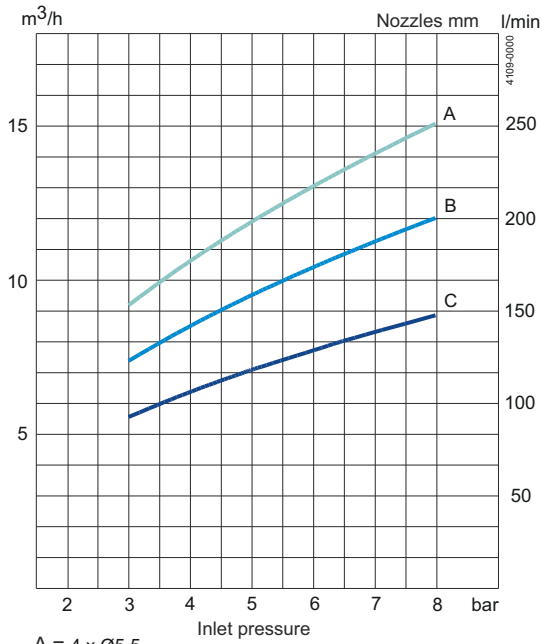

- A = 4 x Ø5.5
- B = 4 x Ø4.6
- C = 4 x Ø3.9

### Impact throw length

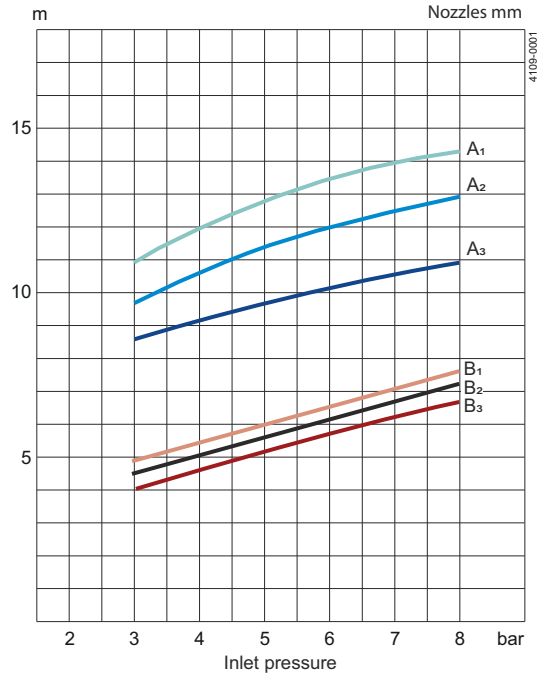

- A: Wetting      B: Impact cleaning
- A<sub>1</sub> = 4 x Ø5.5    B<sub>1</sub> = 4 x Ø5.5
- A<sub>2</sub> = 4 x Ø4.6    B<sub>2</sub> = 4 x Ø4.6
- A<sub>3</sub> = 4 x Ø3.9    B<sub>3</sub> = 4 x Ø3.9

### Cleaning time, complete pattern

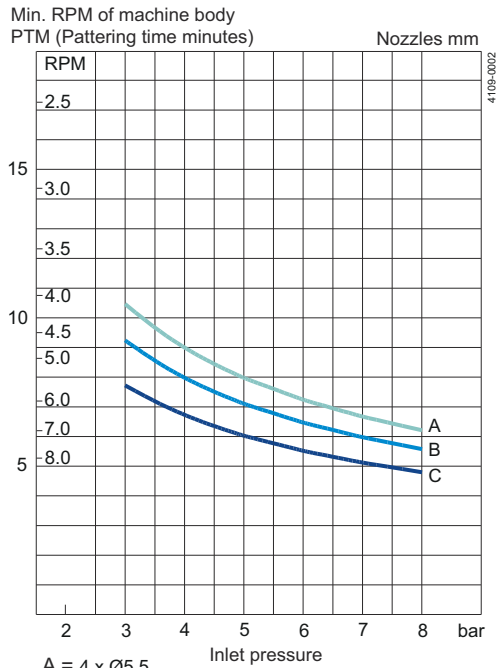

- A = 4 x Ø5.5
- B = 4 x Ø4.6
- C = 4 x Ø3.9

## Dimensions (mm)

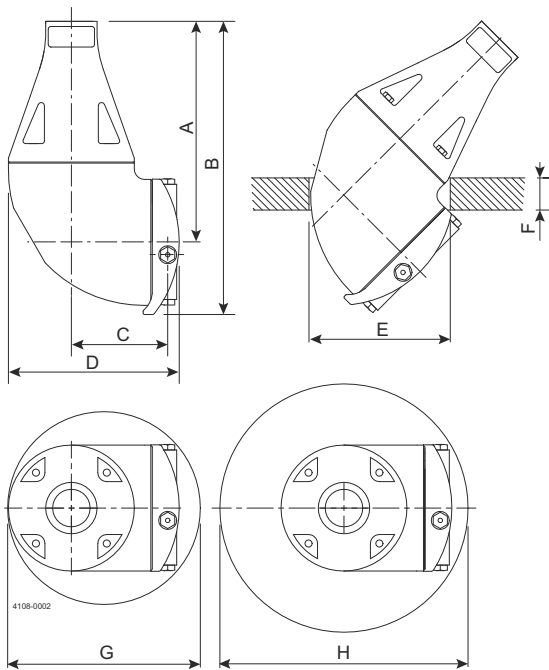

A	B	C	D	E	F	G	H
173	230	75	133	Ø110	Max. 25	Ø150	Ø200

## TRAX simulation tool

TRAX is a unique software that simulates how the Toftejorg MultiJet 25 performs in a specific tank or vessel. The simulation gives information on wetting intensity, pattern mesh width and cleaning jet velocity. This information is used to determine the best location of the tank cleaning machine and the correct combination of flow, time and pressure to implement.

A TRAX demo containing different cleaning simulations covering a variety of applications can be used as reference and documentation for tank cleaning applications. A TRAX simulation is free and available upon request.

## Wetting Intensity

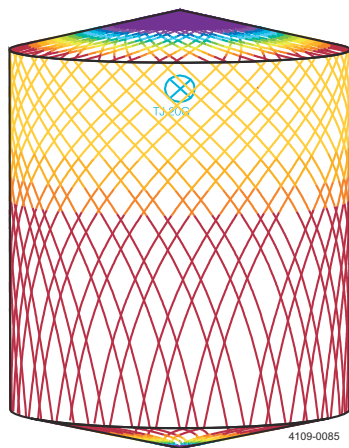
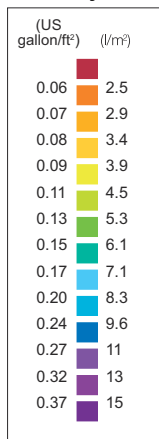

D4.6 m H5.5m, Toftejorg MultiJet 25. 4 x Ø 5.5 mm, Time = 2.08 min, Water consumption = 403 l

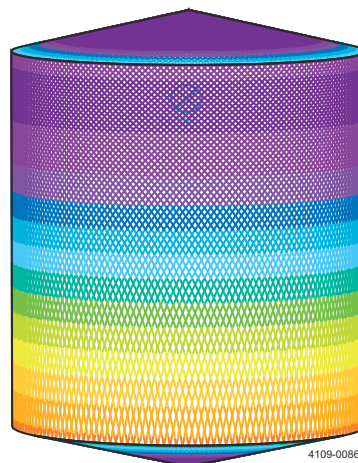

D4.6m H5.5 m, Toftejorg MultiJet 25. 4 x Ø5.5 mm, Time = 8.3 min, Water consumption = 1612 l

This document and its contents are subject to copyrights and other intellectual property rights owned by Alfa Laval Corporate AB. No part of this document may be copied, re-produced or transmitted in any form or by any means, or for any purpose, without Alfa Laval Corporate AB's prior express written permission. Information and services provided in this document are made as a benefit and service to the user, and no representations or warranties are made about the accuracy or suitability of this information and these services for any purpose. All rights are reserved.

200006900-1-EN-GB

© Alfa Laval Corporate AB



**ALFA ENGENHARIA**

Rua Dom Pedro Henrique de Orleans e Bragança, 809 - CEP 05117-002 - Vila Jaguara - São Paulo-SP  
[www.alfaengenharia.com.br](http://www.alfaengenharia.com.br) - [contato@alfaengenharia.com.br](mailto:contato@alfaengenharia.com.br)  
Tel:+55 11 3644-5476